

# SPECIFICATION FOR APPROVAL

<b>CUSTOMER</b>	
<b>PRODUCT NAME</b>	Molding Choke
<b>YUNSHENG PART NO.</b>	YMH05306R8M
<b>CUSTOMER PART NO.</b>	
<b>RELEASE DATE</b>	2019/01/15

【New Released, Revised】

CUSTOMER APPROVE :

THE SPECIFICATION HAS BEEN ACCEPTED.

CONFIRMED :

APPROVED :

DATE :

宁波韵升电子元器件技术有限公司  
Ningbo Yunsheng Electronic Components  
Technology Co., Ltd.  
地址：浙江省宁波市国家高新区沧海路 225 号  
Add: NO.225 Canghai Road, National Hi-tech  
District ,Ningbo City,Zhejiang province.  
Tel :0574-27861369 Fax:0574-27861307

REPORTED BY	CHECKED BY	APPROVED BY

Change Record:			
CHANGE DATE	CHANGE WRITING	YUNSHENG PART NO.	VERSION
2019/01/15	New Version	YMH05306R8M	A
	Following Blank		

### 1 Scope

This specification applies to the large current, low loss power molding choke.

### 2 Product Identification (Part Number)

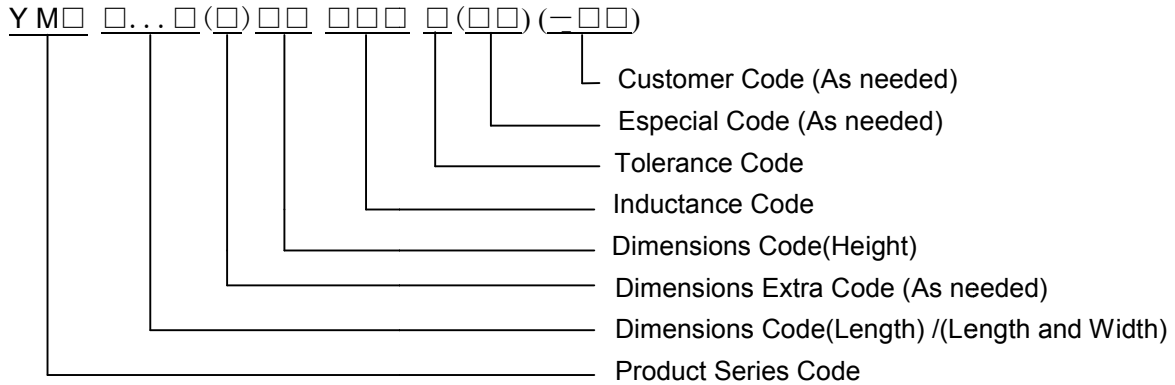

### 3 Rating

- a. Operating temperature range : -40°C~+125°C. ( Including self - temperature rise )
- b. Storage Temperature < 35°C ,Humidity<75% RH.

### 4 Marking and Coating

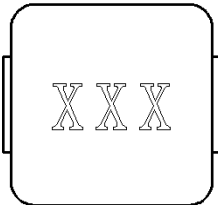

**Example :** YMH05301R0M

**Marking :** 1R0

**Marking color :** White

**Coating:** No Gray Black

### 5 Standard Testing Condition

Temperature	Ambient Temperature(25±3°C)
Humidity	Ambient Humidity(60±20% RH)

## 6 Configuration and Dimensions



Type	Dimensions ( mm )
A	5.2±0.25
B	5.5±0.3
C	2.8±0.2
D	2.2±0.2
E	1.2±0.3

### Recommend Land Pattern Dimensions

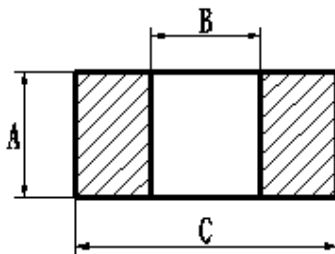

Type	Dimensions ( mm )
A	2.5
B	2.2
C	6.0

## 7 Electrical Characteristic

Part NO.	Inductance ( uH )	Test conditions	Isat(A) Typ.	Irms(A) Typ.	RDC(mΩ) Max./Typ.	Marking
YMH05306R8M	6.8±20%	100kHz, 1.0V	4.3	4.0	74/67	6R8

### Note:

- Irms: DC current (A) that will cause an approximate  $\Delta T$  of 40°C.
- Isat: DC current (A) that will cause  $L_0$  to drop approximately 20%.
- The part temperature (ambient + temp. rise) should not exceed 125 °C under worst case operating conditions.
- Temperature rise is highly depending on many factors, including PCB land pattern, trace size, and proximity to other components. Therefore temperature rise should be verified in application conditions.

## 8 Performance Graphs

### 8.1 Inductance and Temperature Rise VS. DC Bias

Test Instrument	Test Condition
<input checked="" type="checkbox"/> WK 6500B Precision Impedance Analyzer+ WK 6565B Bias Current Source	Temperature: 25 ± 3 °C
<input type="checkbox"/> WK 3260B Precision Impedance Analyzer + WK 3265B Bias Current Source	Humidity: 60 ±20% RH
	Frequency: <input checked="" type="checkbox"/> 100 kHz <input type="checkbox"/> 1MHz
	OSC Level: 1.0V

CURRENT (A)	0	1	2	3	4	4.2	4.5
Ls ( μH)	6.740	6.598	6.344	6.010	5.594	5.506	5.372
Drop	0	2.11%	5.88%	10.83%	17.00%	18.31%	20.30%
ΔT (°C)	0	1.9	7.9	18.9	35.3	39.9	/

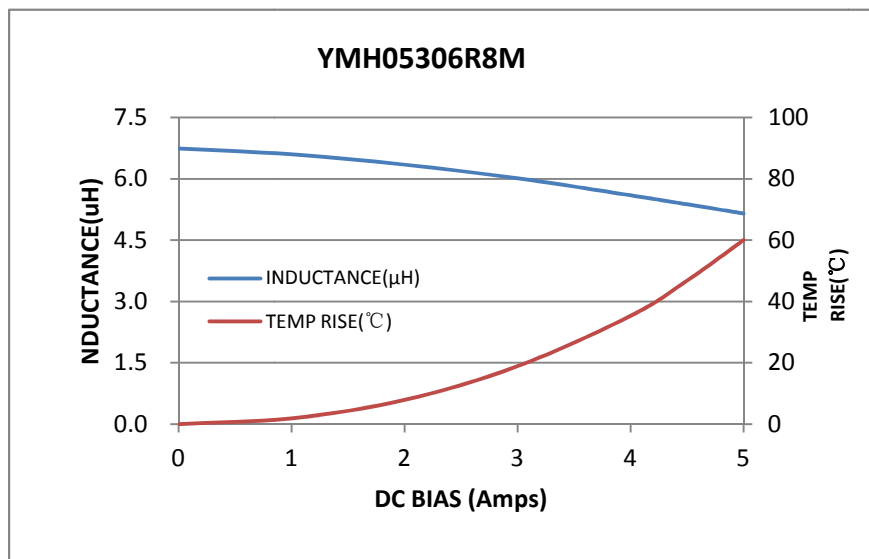

## 9 Structure

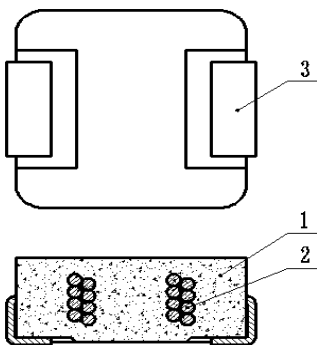

### Material List:

Item	Part	Description
1	Core	Soft magnetic powder
2	Wire	Enameled copper wire
3	Terminal	Tin copper

## 10 Reliability Test

### 10.1 Mechanical Performance

No.	Item	Test Method	Specification
1-1	Solderability	1. Solder Composition: Sn/Ag3.0/Cu0.5 ; 2.Solder Temperature: 245±5°C ; 3.Immersion Time: 5±1sec.	The electrodes shall be at least 95% covered with new solder coating.
1-2	Terminal Strength	1. Solder the sample to the testing PCB using reflow soldering ; 2. Apply a force of 17.7N perpendicular to the lateral side face of the sample for 60±1s.	1. The sample shall not come off the test board ; 2.Terminal without disconnection or no rupture trace on product matrix ; 3.Inductance change: Within ±10%.
1-3	Vibration	1. Solder the sample to the testing PCB using reflow soldering ; 2. Vibration frequency: 10 to 55 to 10Hz for 60 seconds ; 3.Time: 2 hours for each axis (x, y and z) ; 4.Amplitude: the maximum 1.5mm.	1. No mechanical damage in appearance ; 2.Inductance change: Within ±10%.
1-4	Resistance of soldering heat	Solder bath temperature: 260±5 °C Dwell time: 8±1s.	1. No mechanical damage in appearance ; 2.Inductance change: Within ±10%.

### 10.2 Environmental Test

No.	Item	Test Method	Specification
2-1	Temperature shock test	1. 10 cycles, 1 cycle shall consist of: -55+0/-5°C,30±3 minutes→125+5/-0°C,30±3 minutes, Limiting temperatures transition shall be in 15 seconds ; 2. Measured after exposure under standard condition for 24±4 hours.	1. No mechanical damage in appearance ; 2.Inductance change: Within ±10%.
2-2	Damp heat test	1. Storage temperature: 85±2°C ; 2. Relative Humidity: 85±5% ; 3. Duration: 168 +4/-0 hours ; 4. Measured after exposure under standard condition for 24±4 hours.	1. No mechanical damage in appearance ; 2. Inductance change: Within ±10%.
2-3	High temperature	1. Storage temperature: 125+2/-0°C ; 2. Duration: 500 +4/-0 hours ; 3. Measured after exposure under standard condition for 24±4 hours.	1. No mechanical damage in appearance ; 2.Inductance change: Within ±10%.
2-4	Low temperature	1. Storage temperature: -55+2/-0°C ; 2. Duration : 500 +4/-0 hours 3.Measured after exposure under standard condition for 24±4 hours.	1. No mechanical damage in appearance ; 2.Inductance change: Within ±10%.

## 11 Recommended Soldering Technologies

### Re-flowing Profile:

- △ Preheat condition: 150 ~200°C/60~120sec.
- △ Allowed time above 217°C: 60~90sec.
- △ Max temp: 260°C
- △ Max time at max temp: 5sec.
- △ Solder paste: Sn/3.0Ag/0.5Cu
- △ Allowed Reflow time: 2x max

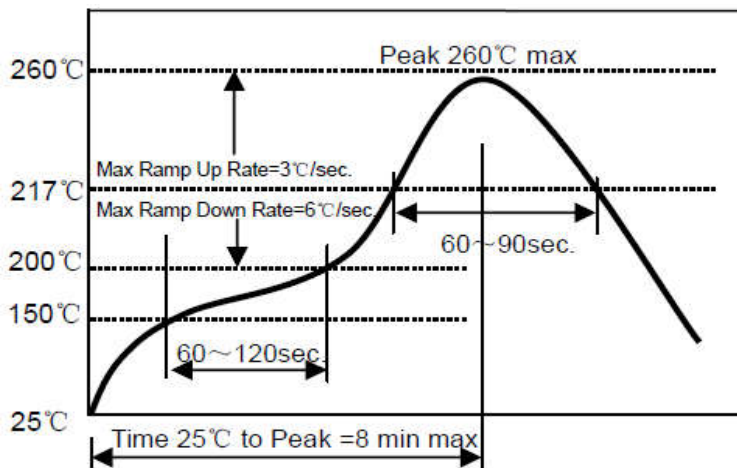

### Note:

The reflow profile in the above table is only for qualification and is not meant to specify board assembly profiles. Actual board assembly profiles must be based on the customer's specific board design, solder paste and process, and should not exceed the parameters as the Reflow profile shows.

## 12 Packaging

### 12.1 Packaging - Cover tape

The peel force of top cover tape shall be between 0.2 to 1.3N.



### 12.2 Tape Dimensions in mm



Type	Carrier Tape Dimensions							
	A	B	T	W	P	F	K	M
0530	5.7	5.9	0.35	12	8	5.5	3.4	1.5

### 12.3 Tape materials

Carrier Tape : polycarbonate (PC , Transparent)

Cover Tape : polystyrene (PS, Transparent , Heat sealing type)

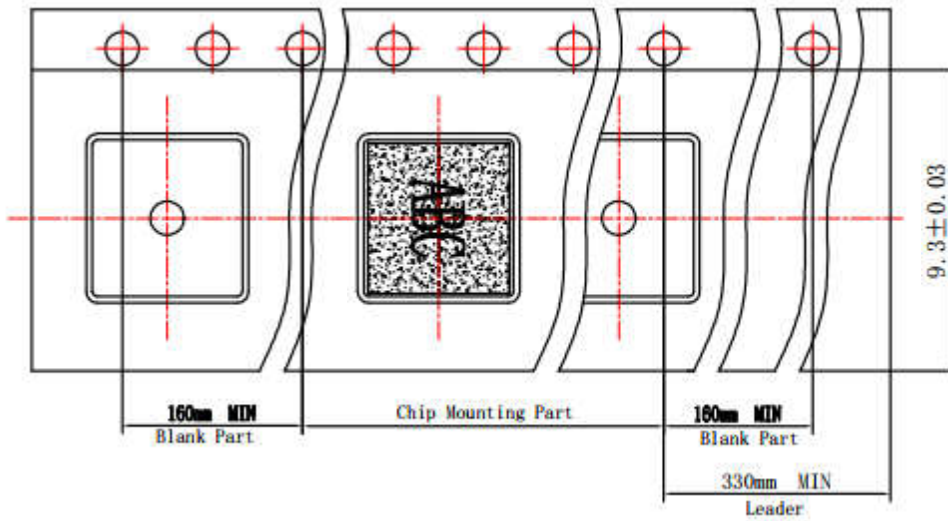

### 12.4 Packaging Quantity

Type	Bulk	Pcs/Reel
0530	/	2000



### 12.5 Reel Dimensions



Reel Dimensions : mm

Type	A	B	C	D
0530	330	100	12.5	2.0

### 13 Notice

1. Please make sure that your product has been evaluated and confirmed against your specifications when our product is mounted to your product.
2. Do not knock nor drop.
3. All the items and parameters in this product specification have been prescribed on the premise that our product is used for the purpose, under the condition and in the environment agreed upon between you and us. You are requested not to use our product deviating from such agreement.
4. Please keep the distance between molding choke and other components (refer to the IEC 950).

## Appendix

### INSPECTION DATA

Test Items	Dimension(mm)				Ls ( $\mu$ H)	Rdc (m $\Omega$ )	$\Delta$ L/L0 (%)	Temp. rise (°C)
	A	B	C	E				
<b>Target</b>	<b>5.20</b>	<b>5.50</b>	<b>2.8</b>	<b>1.20</b>	<b>6.8</b>	<b>67</b>	<b>Isat:4.3A</b>	<b>Irms:4A</b>
<b>Range</b>	<b><math>\pm</math>0.25</b>	<b><math>\pm</math>0.3</b>	<b><math>\pm</math>0.2</b>	<b><math>\pm</math>0.3</b>	<b><math>\pm</math>20%</b>	<b>74Max</b>	<b><math>\approx</math>20 %</b>	<b><math>\leq</math> 40°C</b>
1	5.212	5.692	2.842	1.480	7.154	66.97	18.2	35.3
2	5.213	5.702	2.843	1.462	6.742	66.86	19.0	34.0
3	5.221	5.720	2.844	1.460	6.436	66.93	18.9	37.0
4	5.216	5.703	2.852	1.332	6.904	66.90	18.0	36.0
5	5.224	5.705	2.845	1.338	6.950	66.89	18.5	35.8
Max.	5.224	5.720	2.852	1.480	7.154	66.97	19.0	37.0
Min.	5.212	5.692	2.842	1.332	6.436	66.86	18.0	34.0
Ave.	5.217	5.704	2.845	1.414	6.837	66.91	18.5	35.6